

# STAMFORD®

PI144K - Winding 311

Technical Data Sheet

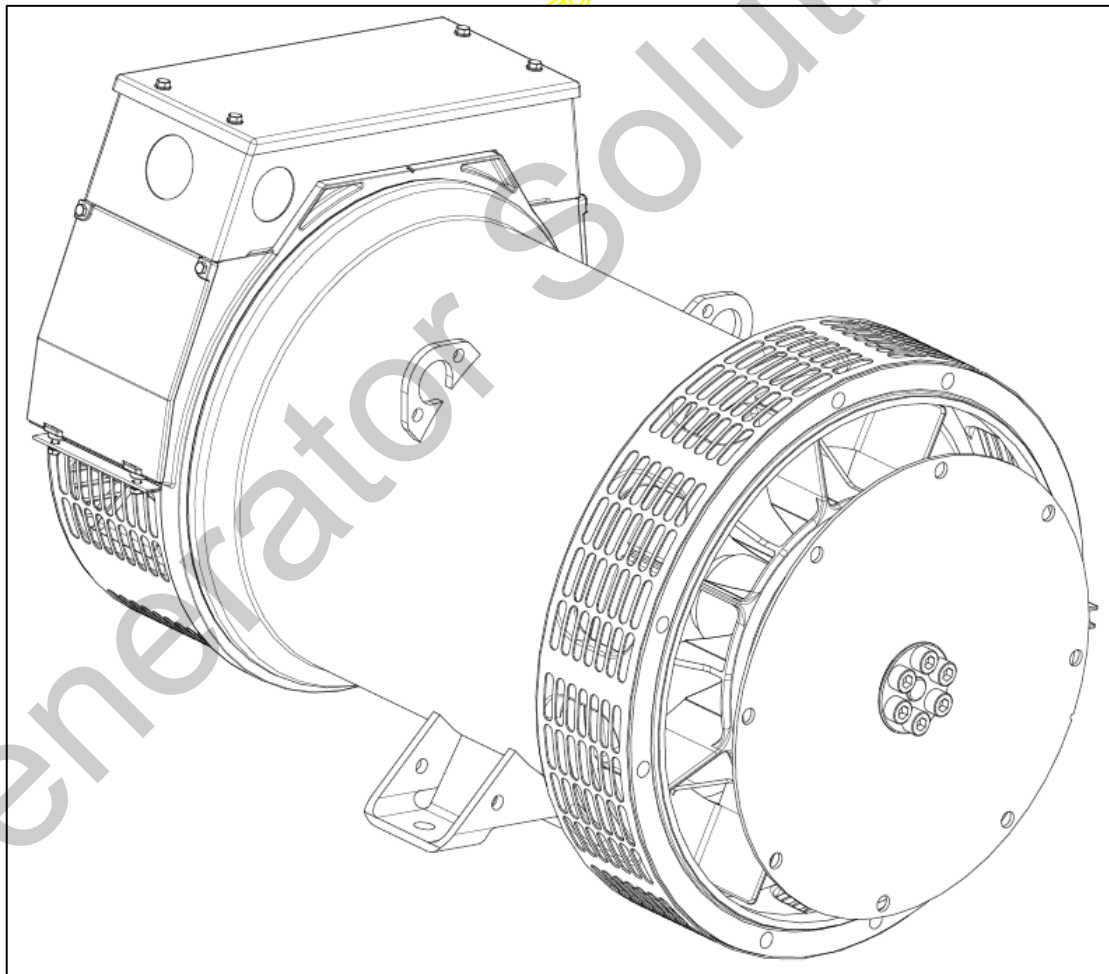

# PI144K

## SPECIFICATIONS & OPTIONS

### STANDARDS

Stamford industrial generators meet the requirements of BS EN 60034 and the relevant section of other international standards such as BS5000, VDE 0530, NEMA MG1-32, IEC34, CSA C22.2-100, AS1359. Other standards and certifications can be considered on request.

### VOLTAGE REGULATOR

#### AS480 AVR fitted as STANDARD

With this self-excited system the main stator provides power via the AVR to the exciter stator. The high efficiency semi-conductors of the AVR ensure positive build-up from initial low levels of residual voltage.

The exciter rotor output is fed to the main rotor through a three-phase full-wave bridge rectifier. The rectifier is protected by a surge suppressor against surges caused, for example, by short circuit or out-of-phase paralleling. The AS480 will support limited accessories, RFI suppression remote voltage trimmer and for the P1 range only a 'droop' Current Transformer (CT) to permit parallel operation with other ac generators.

The AVR is can be fitted to either side of the generator in its own housing in the non-drive end bracket.

#### Excitation Boost System (EBS) (OPTIONAL)

The EBS is a single, self-contained unit, attached to the non-drive end of the generator.

The EBS unit consists of the Excitation Boost Controller (EBC) and an Excitation Boost Generator (EBG). Under fault conditions, or when the generator is subjected to a large impact load such as a motor starting, the generator voltage will drop. The EBC senses the drop in voltage and engages the output power of the EBG. This additional power feeds the generator's excitation system, supporting the load until breaker discrimination can remove the fault or enable the generator to pick up a motor and drive the voltage recovery.

### WINDINGS & ELECTRICAL PERFORMANCE

All generator stators are wound to 2/3 pitch. This eliminates triplen (3rd, 9th, 15th ...) harmonics on the voltage waveform and is found to be the optimum design for trouble-free supply of non-linear loads. The 2/3 pitch design avoids excessive neutral currents sometimes seen with higher winding pitches, when in parallel with the mains. A fully connected damper winding reduces oscillations during paralleling. This winding, with the 2/3 pitch and carefully selected pole and tooth designs, ensures very low waveform distortion.

### TERMINALS & TERMINAL BOX

Standard generators are 3-phase reconnectable with 12 ends brought out to the terminals, which are mounted at the non-drive end of the generator. Dedicated single phase generators are also available. A sheet steel terminal box contains provides ample space for the customers' wiring and gland arrangements. Alternative terminal boxes are available for customers who want to fit additional components in the terminal box.

### SHAFT & KEYS

All generator rotors are dynamically balanced to better than BS6861:Part 1 Grade 2.5 for minimum vibration in operation. Two bearing generators are balanced with a half key.

### INSULATION / IMPREGNATION

The insulation system is class 'H'.

All wound components are impregnated with materials and processes designed specifically to provide the high build required for static windings and the high mechanical strength required for rotating components.

### QUALITY ASSURANCE

Generators are manufactured using production procedures having a quality assurance level to BS EN ISO 9001.

The stated voltage regulation may not be maintained in the presence of certain radio transmitted signals. Any change in performance will fall within the limits of Criteria 'B' of EN 61000-6-2:2001. At no time will the steady-state voltage regulation exceed 2%.

### DE RATES

All values tabulated on page 9 are subject to the following reductions

5% when air inlet filters are fitted.

3% for every 500 metres by which the operating altitude exceeds 1000 metres above mean sea level.

3% for every 5°C by which the operational ambient temperature exceeds 40°C.

Note: Requirement for operating in an ambient exceeding 60°C must be referred to the factory.

5% For reverse rotation

(Standard rotation CW when viewed from DE)

*NB Continuous development of our products entitles us to change specification details without notice, therefore they must not be regarded as binding.*

*Front cover drawing typical of product range.*

# PI144K WINDING 311

**STAMFORD**

CONTROL SYSTEM	STANDARD AS480 AVR (SELF EXCITED)							
VOLTAGE REGULATION	± 1.0 %							
SUSTAINED SHORT CIRCUIT	SELF EXCITED MACHINES DO NOT SUSTAIN A SHORT CIRCUIT CURRENT							
CONTROL SYSTEM	AS480 AVR WITH OPTIONAL EXCITATION BOOST SYSTEM (EBS)							
SUSTAINED SHORT CIRCUIT	REFER TO SHORT CIRCUIT DECREMENT CURVE (page 8)							
STATOR WINDING	DOUBLE LAYER CONCENTRIC							
WINDING PITCH	TWO THIRDS							
WINDING LEADS	12							
STATOR WDG. RESISTANCE	0.153 Ohms PER PHASE AT 22°C SERIES STAR CONNECTED							
ROTOR WDG. RESISTANCE	0.983 Ohms at 22°C							
EXCITER STATOR RESISTANCE	22.9 Ohms at 22°C							
EXCITER ROTOR RESISTANCE	0.21 Ohms PER PHASE AT 22°C							
EBS STATOR RESISTANCE	12.9 Ohms at 22°C							
R.F.I. SUPPRESSION	BS EN 61000-6-2 & BS EN 61000-6-4, VDE 0875G, VDE 0875N. refer to factory for others							
WAVEFORM DISTORTION	NO LOAD < 1.5% NON-DISTORTING BALANCED LINEAR LOAD < 5.0%							
MAXIMUM OVERSPEED	2250 Rev/Min							
BEARING DRIVE END	BALL. 6310 - 2RS. (ISO)							
BEARING NON-DRIVE END	BALL. 6306 - 2RS. (ISO)							
	1 BEARING			2 BEARING				
	WITH EBS	WITHOUT EBS	WITH EBS	WITH EBS		WITHOUT EBS		
WEIGHT COMP. GENERATOR	193 kg	191.3 kg	196 kg	196 kg		194.3 kg		
WEIGHT WOUND STATOR	94 kg	94 kg	94 kg	94 kg		94 kg		
WEIGHT WOUND ROTOR	73.55 kg	71.85 kg	75.26 kg	75.26 kg		73.56 kg		
WR <sup>2</sup> INERTIA	0.2866 kgm <sup>2</sup>	0.2849 kgm <sup>2</sup>	0.2871 kgm <sup>2</sup>	0.2871 kgm <sup>2</sup>		0.2854 kgm <sup>2</sup>		
SHIPPING WEIGHTS in a crate	211 kg	209.3 kg	220 kg	220 kg		218.3 kg		
PACKING CRATE SIZE	85 x 51 x 67 (cm)			85 x 51 x 67 (cm)				
	50 Hz			60 Hz				
TELEPHONE INTERFERENCE	THF < 2%			TIF < 50				
COOLING AIR	0.135 m <sup>3</sup> /sec 286cfm			0.165 m <sup>3</sup> /sec 340 cfm				
VOLTAGE SERIES STAR	380/220	400/231	415/240	440/254	416/240	440/254	460/266	480/277
VOLTAGE PARALLEL STAR	190/110	200/115	208/120	220/127	208/120	220/127	230/133	240/138
VOLTAGE SERIES DELTA	220/110	230/115	240/120	254/127	240/120	254/127	266/133	277/138
kVA BASE RATING FOR REACTANCE VALUES	42.5	42.5	42.5	40.4	50	52.5	52.5	55
X <sub>d</sub> DIR. AXIS SYNCHRONOUS	1.98	1.79	1.66	1.41	2.51	2.36	2.16	2.07
X' <sub>d</sub> DIR. AXIS TRANSIENT	0.19	0.17	0.16	0.13	0.24	0.23	0.21	0.20
X'' <sub>d</sub> DIR. AXIS SUBTRANSIENT	0.13	0.12	0.11	0.09	0.17	0.16	0.15	0.14
X <sub>q</sub> QUAD. AXIS REACTANCE	0.95	0.86	0.80	0.68	1.21	1.14	1.04	1.00
X'' <sub>q</sub> QUAD. AXIS SUBTRANSIENT	0.21	0.19	0.18	0.15	0.27	0.25	0.23	0.22
X <sub>L</sub> LEAKAGE REACTANCE	0.08	0.07	0.07	0.05	0.10	0.09	0.09	0.08
X <sub>2</sub> NEGATIVE SEQUENCE	0.18	0.16	0.15	0.13	0.22	0.21	0.19	0.18
X <sub>0</sub> ZERO SEQUENCE	0.08	0.07	0.07	0.05	0.10	0.09	0.09	0.08
REACTANCES ARE SATURATED				VALUES ARE PER UNIT AT RATING AND VOLTAGE INDICATED				
T' <sub>d</sub> TRANSIENT TIME CONST.	0.03 s							
T'' <sub>d</sub> SUB-TRANSTIME CONST.	0.007 s							
T' <sub>do</sub> O.C. FIELD TIME CONST.	0.68 s							
T <sub>a</sub> ARMATURE TIME CONST.	0.007 s							
SHORT CIRCUIT RATIO	1/X <sub>d</sub>							

50  
Hz

PI144K  
Winding 311

STAMFORD

THREE PHASE EFFICIENCY CURVES

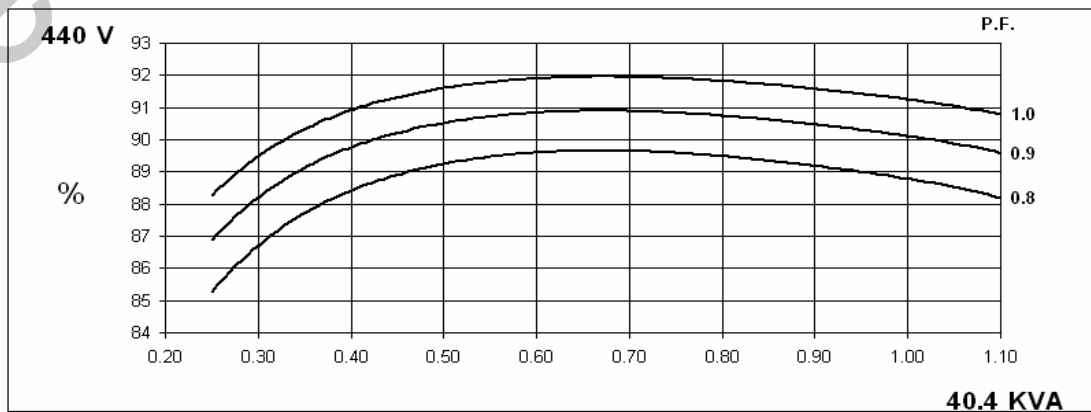
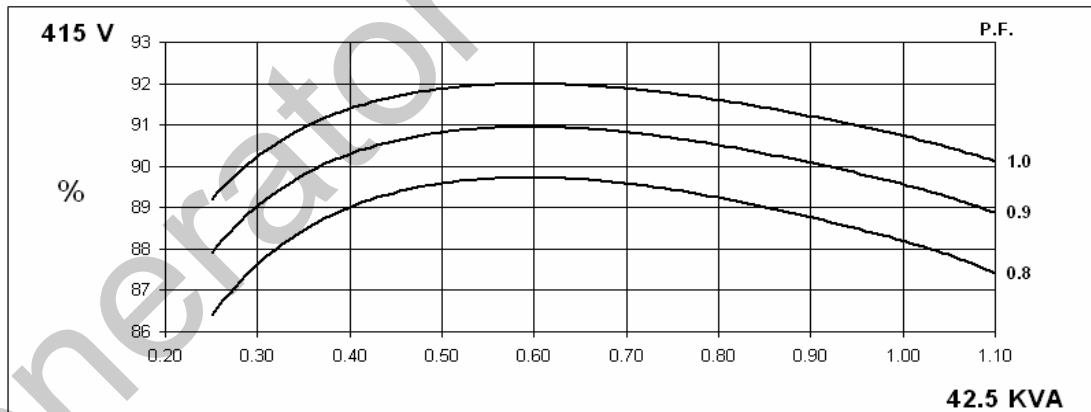
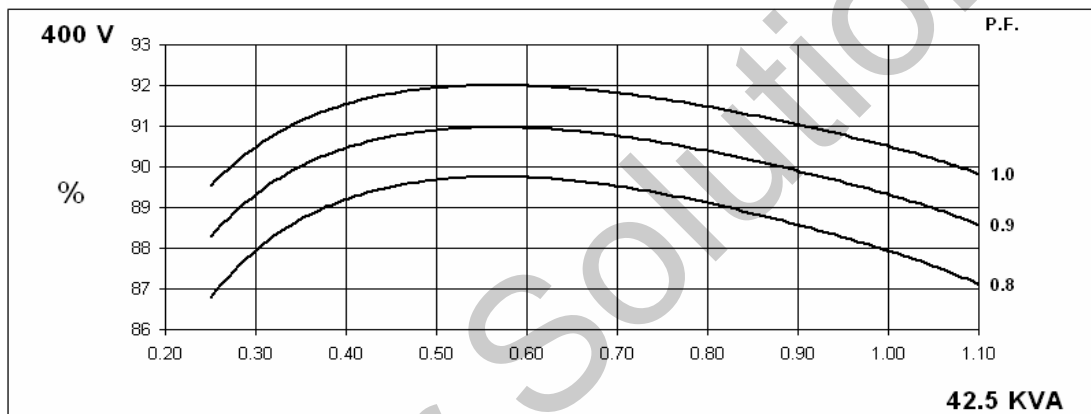
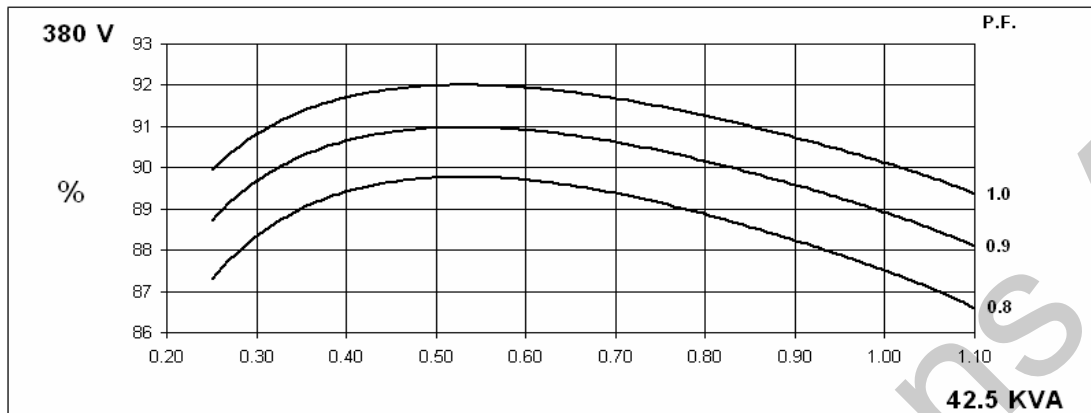

60  
Hz

PI144K  
Winding 311

**STAMFORD**

**THREE PHASE EFFICIENCY CURVES**

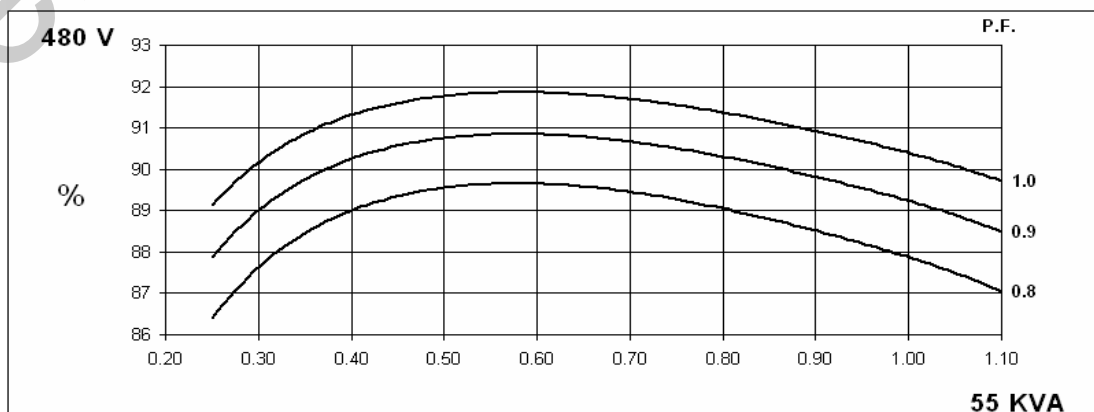
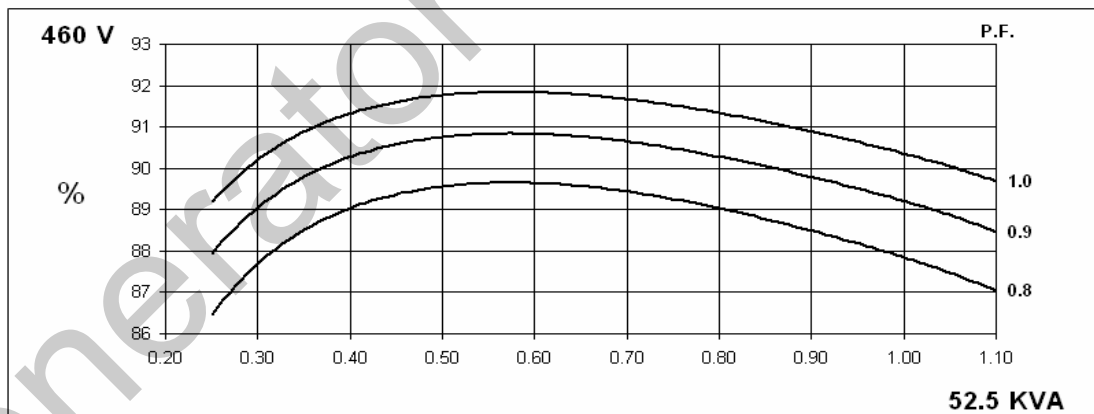
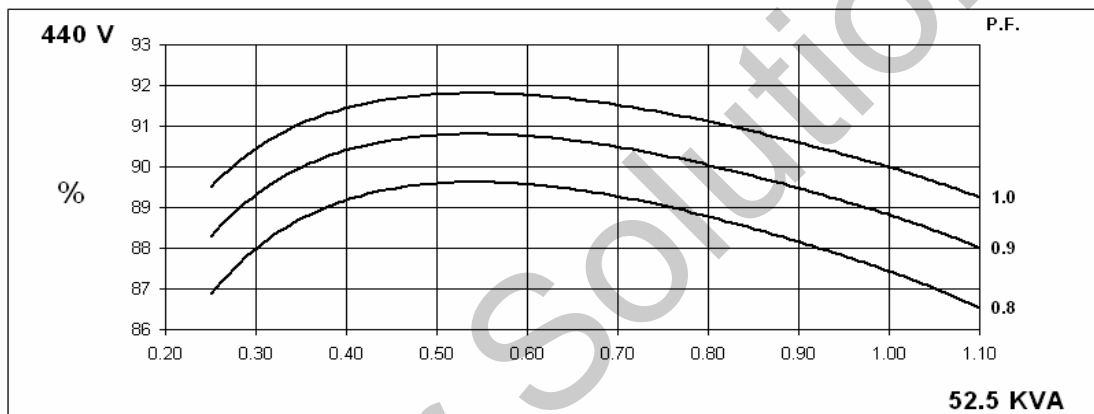
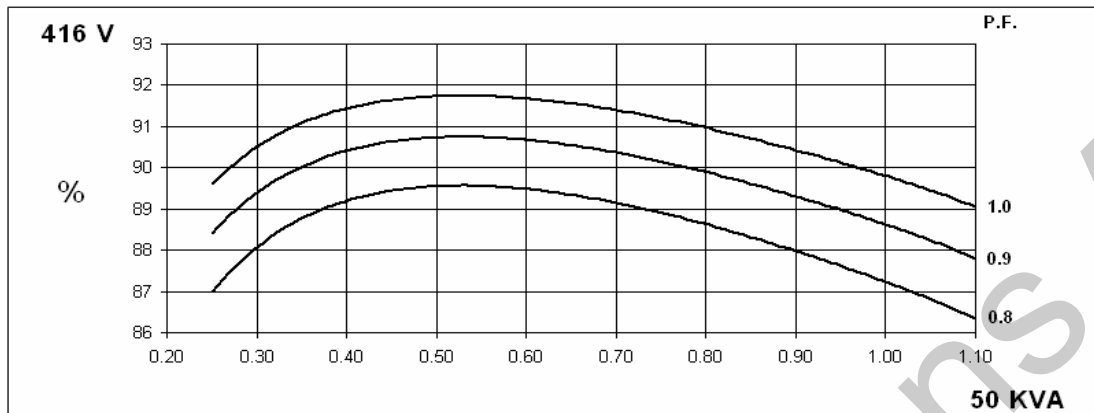

**PI144K**  
**Winding 311**  
**AS480 AVR Without EBS**  
**Locked Rotor Motor Starting Curves**

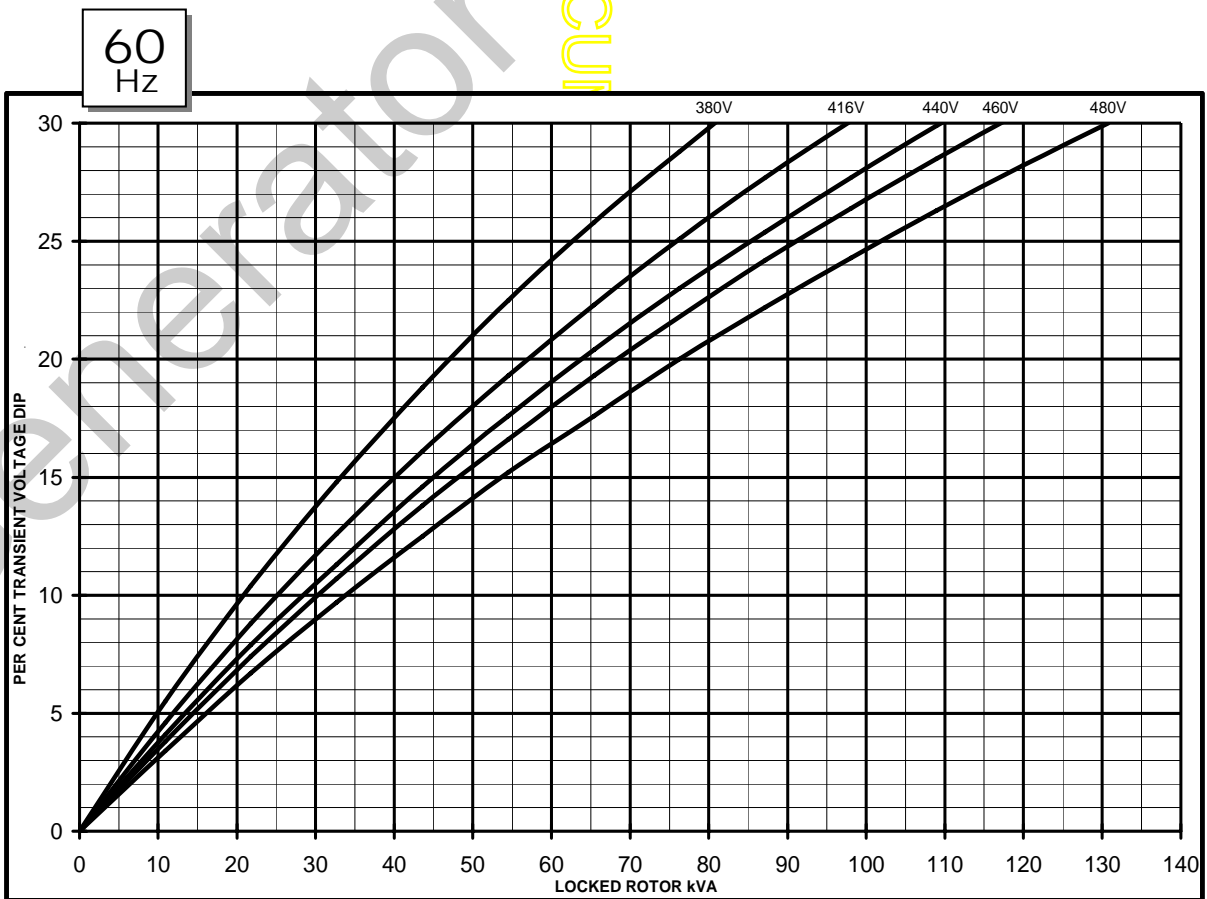
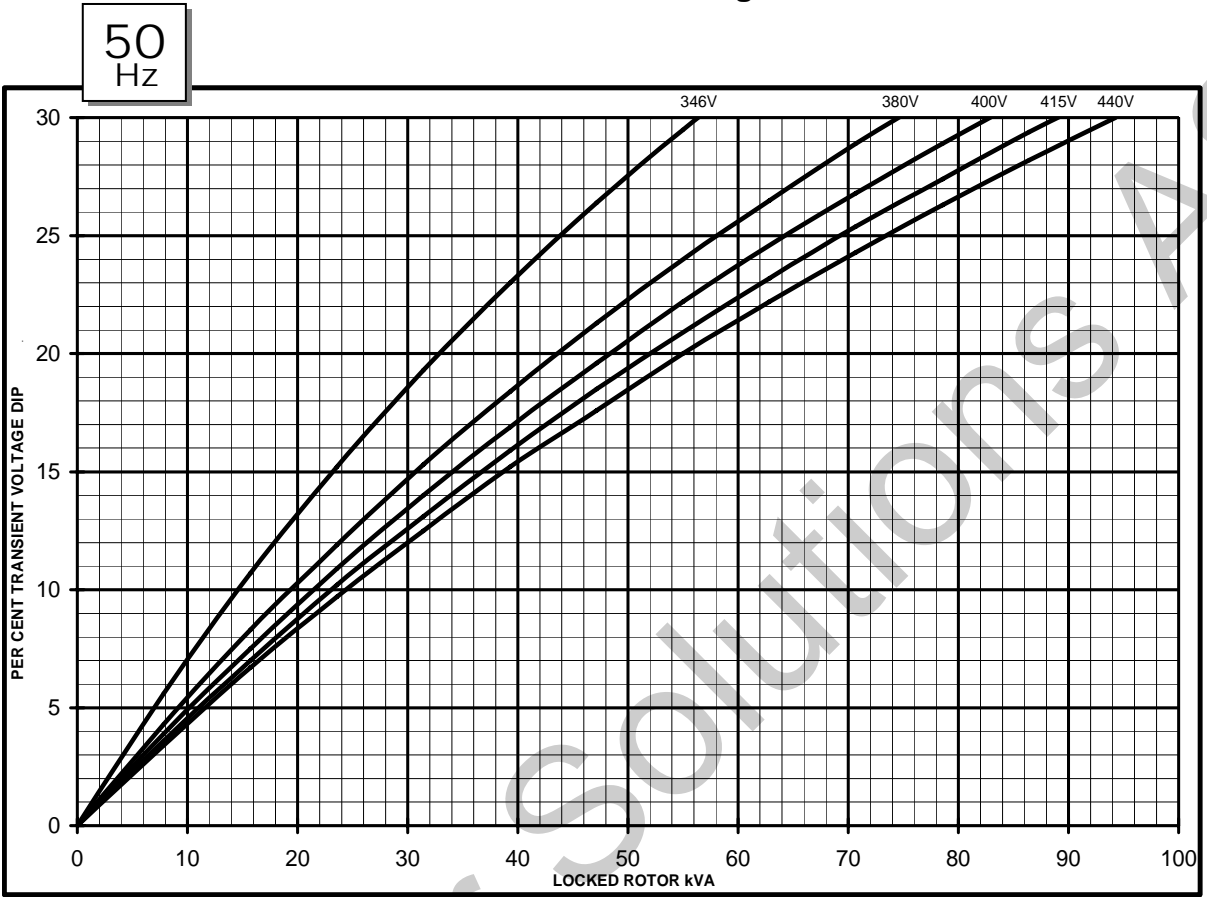

PI144K  
Winding 311  
AS480 AVR With EBS fitted  
Locked Rotor Motor Starting Curves

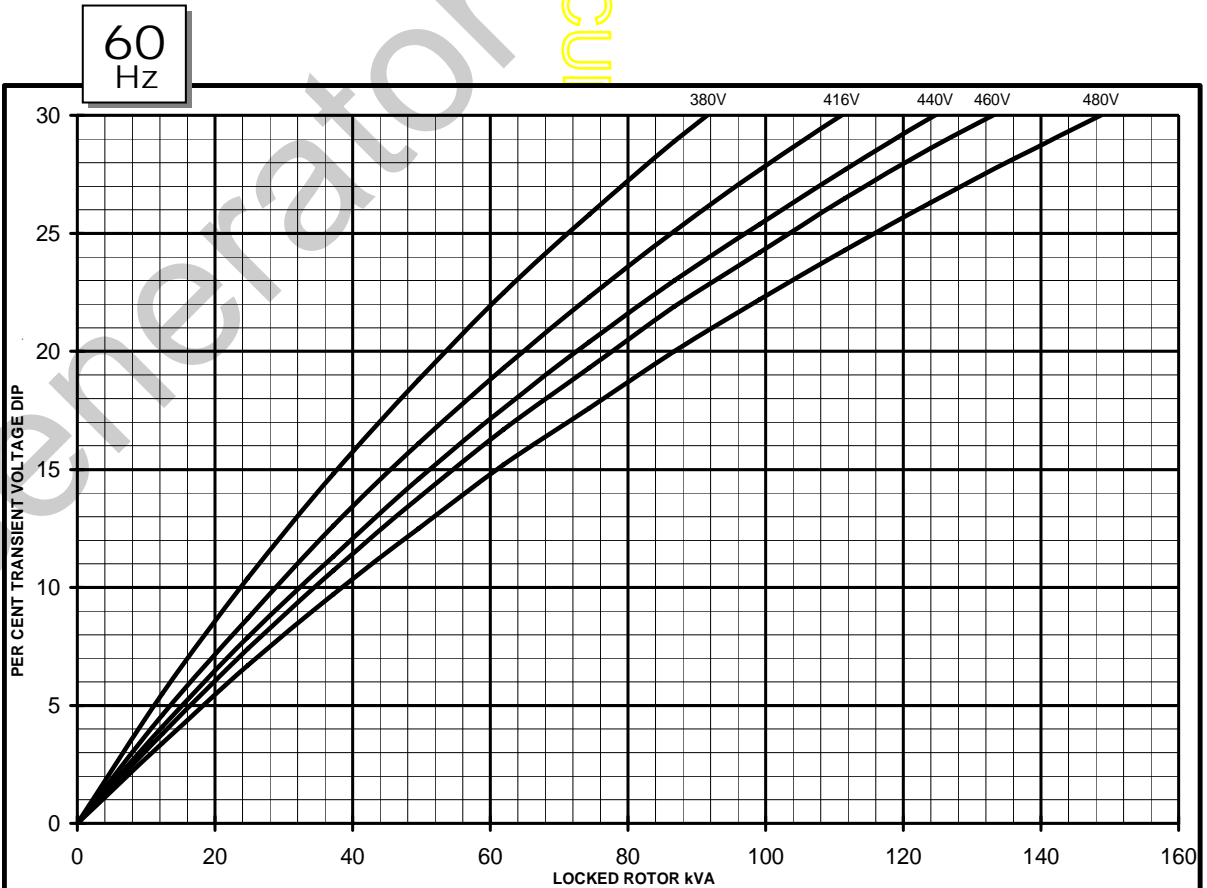
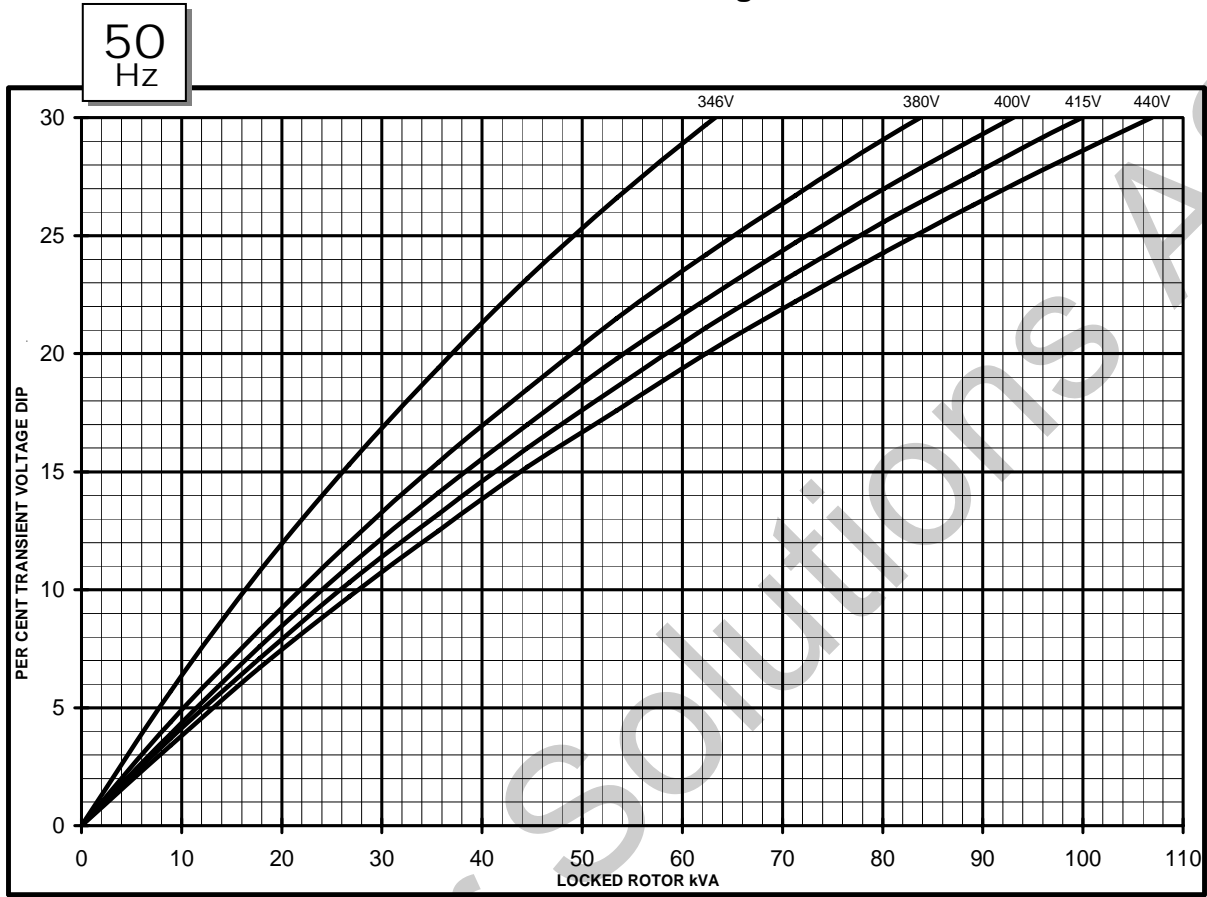

PI144K  
WITH EBS FITTED

**STAMFORD**

Three-phase Short Circuit Decrement Curve. No-load Excitation at Rated Speed  
Based on star (wye) connection.

50  
Hz

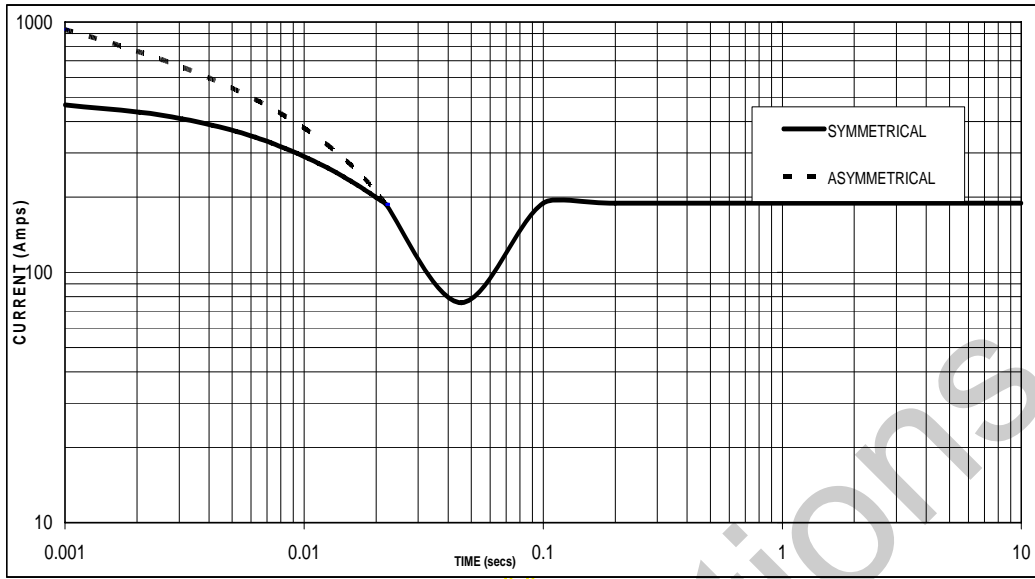

Sustained Short Circuit = 189 Amps

60  
Hz

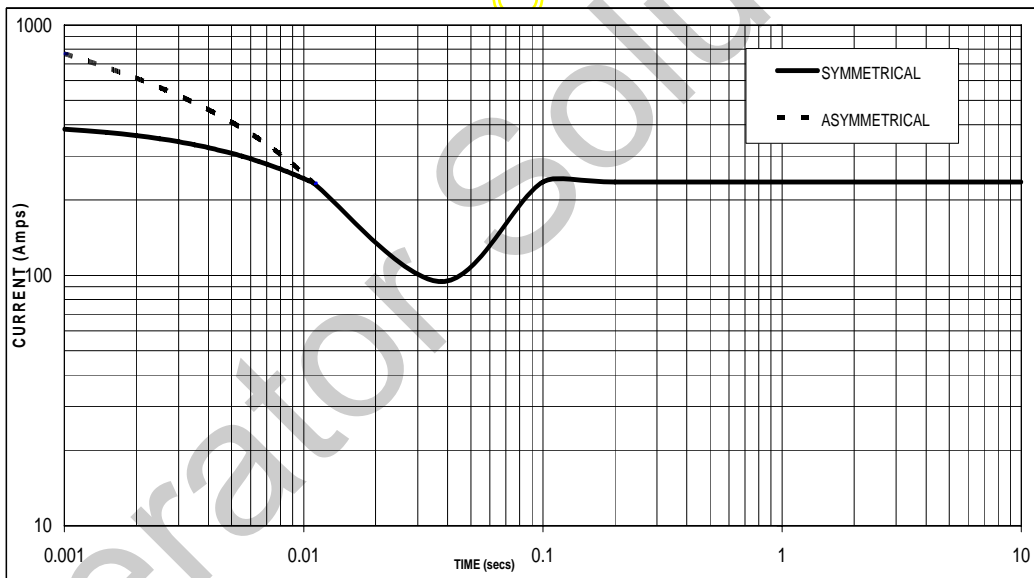

Sustained Short Circuit = 236 Amps

**Note 1**

The following multiplication factors should be used to adjust the values from curve between time 0.001 seconds and the minimum current point in respect of nominal operating voltage :

50Hz		60Hz	
Voltage	Factor	Voltage	Factor
380v	X 1.00	416v	X 1.00
400v	X 1.05	440v	X 1.06
415v	X 1.09	460v	X 1.10
440v	X 1.16	480v	X 1.15

The sustained current value is constant irrespective of voltage level

**Note 2**

The following multiplication factor should be used to convert the values calculated in accordance with NOTE 1 to those applicable to the various types of short circuit :

	3-phase	2-phase L-L	1-phase L-N
Instantaneous	x 1.00	x 0.87	x 1.30
Minimum	x 1.00	x 1.80	x 3.20
Sustained	x 1.00	x 1.50	x 2.50
Max. sustained duration	10 sec.	5 sec.	2 sec.

All other times are unchanged

**Note 3**

Curves are drawn for Star (Wye) connected machines. For other connection the following multipliers should be applied to current values as shown :

Parallel Star = Curve current value X 2

Series Delta = Curve current value X 1.732



**PI144K**  
**Winding 311 / 0.8 Power Factor**

**RATINGS**

Class - Temp Rise	Cont. F - 105/40°C				Cont. H - 125/40°C				Standby - 150/40°C				Standby - 163/27°C				
<b>50 Hz</b>	Series Star (V)	380	400	415	440	380	400	415	440	380	400	415	440	380	400	415	440
	Parallel Star (V)	190	200	208	220	190	200	208	220	190	200	208	220	190	200	208	220
	Series Delta (V)	220	230	240	254	220	230	240	254	220	230	240	254	220	230	240	254
kVA	37.5	37.5	37.5	35.6	42.5	42.5	42.5	40.4	45.0	45.0	45.0	42.8	46.8	46.8	46.8	44.5	
kW	30.0	30.0	30.0	28.5	34.0	34.0	34.0	32.3	36.0	36.0	36.0	34.2	37.4	37.4	37.4	35.6	
Efficiency (%)	88.4	88.7	88.8	89.3	87.6	87.9	88.1	88.8	87.1	87.5	87.7	88.5	86.8	87.2	87.4	88.2	
kW Input	33.9	33.8	33.8	31.9	38.8	38.7	38.6	36.4	41.3	41.1	41.0	38.7	43.1	42.9	42.8	40.3	

<b>60 Hz</b>	Series Star (V)	416	440	460	480	416	440	460	480	416	440	460	480	416	440	460	480
	Parallel Star (V)	208	220	230	240	208	220	230	240	208	220	230	240	208	220	230	240
	Delta (V)	240	254	266	277	240	254	266	277	240	254	266	277	240	254	266	277
kVA	45.0	46.3	46.3	48.0	50.0	52.5	52.5	55.0	53.1	55.0	55.0	58.1	55.0	56.3	56.3	60.0	
kW	36.0	37.0	37.0	38.4	40.0	42.0	42.0	44.0	42.5	44.0	44.0	46.5	44.0	45.0	45.0	48.0	
Efficiency (%)	88.3	88.5	88.8	88.8	87.6	87.7	88.1	88.0	87.1	87.4	87.7	87.6	86.8	87.2	87.6	87.4	
kW Input	40.8	41.8	41.7	43.2	45.7	47.9	47.7	50.0	48.8	50.3	50.2	53.1	50.7	51.6	51.4	54.9	

**DIMENSIONS**

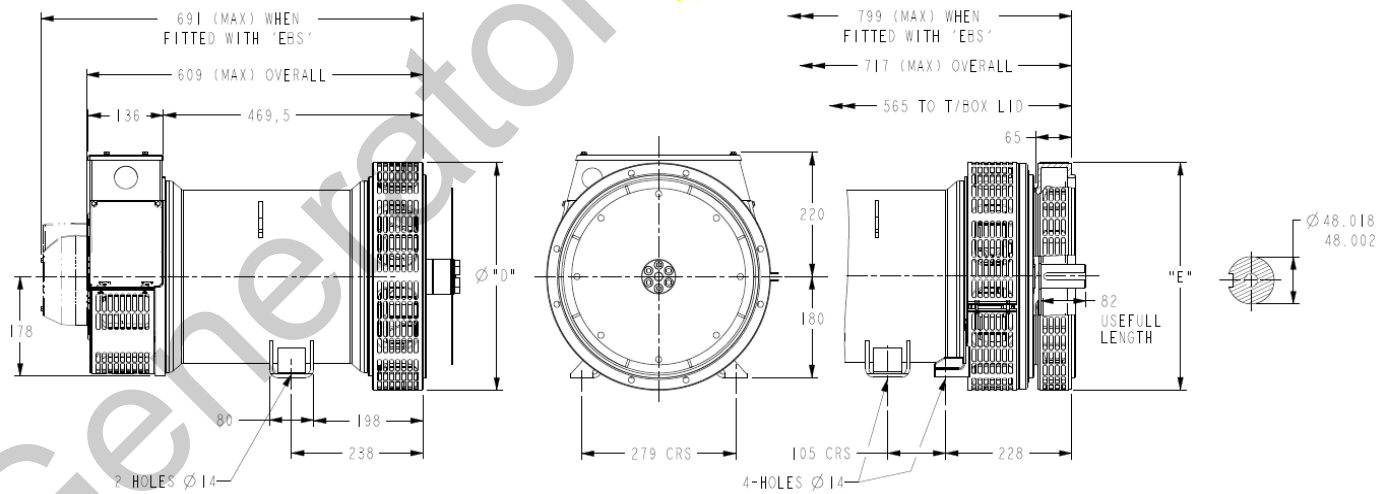

COUPLING DISC	
SAE	"AN"
8	62
10	53.8
11.5	39.6

1-BRG ADAPTOR	
SAE	"D"
4	405
3	451
2	489

8-HOLES SPACED AS 12  
 8-HOLES SPACED AS 12

2-BRG ADAPTOR	
SAE	"E"
5	359
4	406
3	455
2	493

Generator Solutions AS

APPROVED DOCUMENT

**STAMFORD**

Head Office Address:  
Barnack Road, Stamford  
Lincolnshire, PE9 2NB  
United Kingdom

Tel: +44 (0) 1780 484000  
Fax: +44 (0) 1780 484100

[www.cumminsgeneratortechnologies.com](http://www.cumminsgeneratortechnologies.com)

Copyright 2010, Cummins Generator Technologies Ltd, All Rights Reserved  
Stamford and AvK are registered trade marks of Cummins Generator Technologies Ltd  
Cummins and the Cummins logo are registered trade marks of Cummins Inc.